

SHRIMATI INDIRA GANDHI COLLEGE
(Nationally Accredited at “A” Grade (3rd cycle) By NAAC)
Tiruchirappalli -2

TUTORIAL MATERIAL
MOLECULAR BIOLOGY

By

DR.B.Varalakshmi, Associate Professor,
Department of Biochemistry

2017 -2018



DEPARTMENT OF BIOCHEMISTRY
SHRIMATI INDIRA GANDHI COLLEGE

**M.Sc BIOCHEMISTRY
MOLECULAR BIOLOGY**

S.No	CONTENTS	Page No
1.	PART A QUESTIONS	3
2.	DNA REPLICATION	10
3.	ENZYMES OF REPLICATION	15
4.	TRANSCRIPTION	20
5.	DIFFERENCE BETWEEN RNA AND DNA	21
6.	POST TRANSCRIPTIONAL PROCESSING	22
7.	MECHANISM OF SPLICING	24
8.	GENETIC CODE AND TRANSLATION	26
9.	MOLECULAR MARKERS	34
10	TEHNIQUES IN MOLECULAR BIOLOGY	35
11	GEL ELECTROPHORESIS FOR BLOTTING	36
12	WESTERN BLOTTING	37
13	DNA FOOT PRINTING DNA FINGER PRINTING	41
14	DNA SEQUENCING	44

MOLECULAR BIOLOGY**PART A****STRUCTURE OF DNA**

1. Compare and contrast Heterochromatin and Euchromatin.

Heterochromatin:

Transcriptionally inactive, methylated, deacetylated histones, dark-staining on electron microscopy.

Euchromatin:

Transcriptionally active, unmethylated DNA, acetylated histones, light-staining on electron microscopy

2. SRP (signal recognition peptide) is important for what cell function?

The SRP binds to the N-terminal amino acid signal during initial synthesis of proteins destined for the plasma membrane or the organelles of the endocytic or exocytic pathways. SRP binding to the newly synthesized N-terminal signal sequence arrests synthesis on free ribosomes to provide time for the complex to bind to an SRP receptor on the RER. Subsequently the SRP is released, which allows protein synthesis to continue simultaneously with proper insertion into the RER membrane or RER lumen

3. Which motor proteins are directed towards the (+) end of microtubules, i.e. those ends that are located towards the outside of the cell and are used in anterograde transport?

Kinesins are (+) directed motor proteins

4. Mention the types of nucleotides in DNA.

Deoxy adenosine monophosphate/ dAMP /d - Adenylic acid. Deoxy guanosine monophosphate/ dGMP /d - Guanylic acid. Deoxy Cytidine monophosphate/ dCMP /dCytidylic acid. Deoxy thymidine mono phosphate/ dTMP /d - Thymidylic acid

5. Name the pentose sugar present in DNA. Name the pentose sugar present in RNA.

Deoxyribose Ribose

6. Mention the name s of pyrimidines of DNA.

Cytosine and Thymine

7. Mention the name s of pyrimidine s of RNA

Uracil and Cytosine.

8. Mention the names of purines of DNA

Adenine and Guanine

9. Mention the names of purines of RNA

Adenine and Guanine

10. What phase of the cell cycle do these errors in replication occur in?

Microsatellite instability can predispose to cancer. These result from errors in replication, which occur during S-phase.

11. What is a nucleoside? What is a nucleotide?

It is a combination of nitrogenous base pentose sugar. Nitrogenous base pentose sugar and phosphate.

12. Name the unstable RNA. Name the least occurring type of RNA..

Messenger RNA.

13. Name the smallest RNA. Name the RNA capable of carrying amino acids.

Transfer RNA.

14. Name the scientist who discovered mRNA

Volkin.

15. Name the most abundant RNA. Name the largest RNA

Ribosomal RNA. rRNA

16. Name the scientist who proposed the fine structure of gene

Seymour Benzer

17. Give reason – why DNA is acidic in nature?

Due to the presence of phosphoric acid or phosphate group

DNA REPAIR

18. What special repair of the replication errors that occur in the cell cycle S phase, happen in what subsequent phase?

Repair of replication errors occurs during G2 (specifically mismatch repair)

19. What are the 5 phases of the cell cycle? Which phase do inactive cells live most of their lives in? Which phase do active cells spend the most time in?

The five phases are G0, G1, S, G2, and M. Inactive cells spend most of their life cycles in G0 (e.g. neurons). Active cells spend most of their life cycles in G1 (e.g. intestinal epithelial cells).

20. DNA repair of what error can take place in the S phase of the cell cycle? Which method of repair is employed?
Proofreading action of DNA polymerase III (prokaryotes) and DNA polymerase D and A (eukaryotes) removes incorrect bases with a 3' to 5' exonuclease activity.
21. DNA repair of what error can take place in the G2 phase of the cell cycle? Which method of repair is employed
DNA mismatch base repair occurs here via hMLH1 and hMSH2 gene activity
22. How does methylation of certain sequences of DNA affect the transcription of those regions.
Methylation of DNA (particularly CG sequences) are typically associated with silencing certain gene regions
23. Name some of the most important genes associated with maintaining fidelity of replicating DNA, and whose loss of function is associated with the development of cancer.
G0 phase: XP (thymine dimer- bulky lesion-repair)
G1 phase (check point): Rb, TP53
G2 phase: MLH1, MSH2 (mismatch repair)
S phase: DNA polymerase proofreading during DNA synthesis.
24. What type of DNA damage is base excision repair used for?
Base excision repair recognizes and repairs individual bases damages by chemical modification (e.g. deamination of cytosine to uracil)
25. What is Photolyase and what is its job? What other cellular mechanisms perform the same function?
Photolyase is an enzyme that mediates the direct repair of ultraviolet (UV) radiation-induced pyrimidine dimers by breaking the abnormal covalent bonds between the adjacent pyrimidines. Global genomic nucleotide excision repair and Transcription-coupled nucleotid excision repair perform similar functions.
26. Xeroderma pigmentosum is due to defects in what type of cellular repair mechanism?
Deficiencies in nucleotide excision repair proteins lead to the development of Xeroderma pigmentosum.

DNA REPLICATION

27. What is the job of DNA Topoisomerase vs. DNA Helicase?

DNA Topoisomerase relieves the tension on the DNA upstream and downstream of the replication fork by cutting the DNA allowing it to unravel, and resealing the nick. DNA Helicase uses ATP energy to unwind the dsDNA at the replication fork.

28. Where are DNA polymerases located in the Nucleus or Nucleolus

DNA Polymerases are largely restricted to the nucleus, but not to the nucleolus, because it participates in DNA replication, rather than ribosome synthesis.

29. Which form of chromatin is loosely packed and transcriptionally active? Is this the form that DNA takes during mitosis

Euchromatin is seen as the loosely packed, "open", transcriptionally active form of chromatin. During mitosis Euchromatin becomes condensed to form Heterochromatin, in which the nucleic acid wraps tightly around histones.

30. Why DNA replication is called semi - conservative

Parental strands are conserved in daughter DNA molecule. Or

Daughter molecule has one parental strand and one new strand

TRANSCRIPTION

31. What type of RNA polymerase is confined to the Nucleolus of the cell?

The nucleolus is the structure of the cell that is required for ribosomal synthesis. While all RNA polymerases are located in the nucleus, only RNA Polymerase I is restricted to the nucleolus, because it is involved in the synthesis of 28S, 18S, and 5.8S rRNAs, which are employed for ribosome synthesis.

32. What is the function of RNA Polymerase II? Where is it found

RNA polymerase II is the primary polymerase that transcribes DNA to RNA. It is found all around the nucleus

33. What are the jobs of RNA Polymerase III?

RNA Polymerase III synthesizes tRNA, but also rRNAs and other small RNAs found in the cytosol and nucleus

34. RNA Polymerase III synthesizes tRNA, but also rRNAs and other small RNAs found in the cytosol and nucleus.

TYPES OF RNA AND ITS PROCESSING

35. Name the codon with double function.

AUG.

36. Why Chargaff's rule is not applicable for RNA?

Because RNA is single stranded.

37. Why the nucleotide ratio in RNA is not usually constant?

Due to the absence of complementary base pairing, RNA is single stranded.

38. Why is processed mRNA in eukaryotes is shorter than its gene?

Because the eukaryotic gene is split gene and the transcribed mRNA has intron portions.

39. What are introns?

The nucleotide sequence is found between the exons and do not code for amino acids

40. Name the cell organelle where protein synthesis takes place?

Ribosome.

41. Write the central dogma of life

DNA ----- Transcription RNA ---- Translation PROTEIN

42. When does Posttranscriptional regulation occurs?

Posttranscriptional regulation occurs after transcription but before translation.

43. What are some of the key sequences within a promoter that RNA polymerase binds to ?

“Pribnow box”, CAAT box, GC box

44. What are all type post-transcriptional modifications involved in the control of gene expression.?

mRNA processing, methylation, polyadenylation

TRANSLATION

45. Name the enzyme, which directs DNA synthesis by RNA. Name the pentose sugar present in RNA

Reverse transcriptase , Ribose

46. Name the pyrimidine, present in DNA, but not in RNA . Name the pyrimidine, present in RNA, but not in DNA.

Thymine, Uracil

47. Why codons are redundant?

Codons are redundant because, single amino acid can be coded by two or three codons

48. Why codons are sensible?

Codons codes for a specific amino acid.

49. Why redundancy concept of genetic code does not apply to all amino acids

Some amino acids like tryptophan and methionine have one codon each.

50. During translation, if the codon is AUG, then, What is the anti codon present on the complimentary tRNA ?

UAC. During translation, if the codon is

AUG, then Name the amino acid carried by this tRNA Methionine

51. How many amino acids are present in a nascent polypeptide decoded from mRNA with the reading frame having 1002 nucleotides?

333 amino acids. Out of 334 amino acid, methionine being first amino acid, which will be removed off, when processing of polypeptide chain takes place

52. What are non – sense codons? Mention 2 of them.

These codons do not code for any amino acids. When these codons appear on mRNA termination of polypeptide chain takes place. UAA,UGA,UAG

53. Where are the codons and anticodons

Codons are present in mRNA and code for Amino acids during proteinsynthesis, Anticodons are present in tRNA and recognise codons on mRNA.

54. What are enhancer elements?

Enhancer elements are DNA sequences that associate with certain proteins that enhance transcription. DNA can fold upon itself to bring any enhancer element into close proximity to a promoter region.

55. Which evidence that primitive life forms lacked both DNA and enzymes.?

RNA can both code genetic information and act as a catalyst

REGULATION OF GENE EXPRESSION

56. Bacterial protein called catabolic activator protein (CAP) is an example of which type of regulation?

second type of positive control of gene expression

57. What is epigenetic gene regulation?

DNA is regulated other than the sequence is called epigenetic regulation. DNA methylation and chromatin structure also involve in regulation of gene expression.

58. In *E. coli*, the inability of the lac repressor to bind an inducer would result in
- (A) No substantial synthesis of β -galactosidase
 - (B) Constitutive synthesis of β -galactosidase
 - (C) Inducible synthesis of β -galactosidase
 - (D) Synthesis of inactive β -galactosidase
 - (E) Synthesis of β -galactosidase only in the absence of lactose
59. If the genetic code consisted of four bases per codon rather than three, the maximum number of unique amino acids that could be encoded would be
- (A) 16
 - (B) 64
 - (C) 128
 - (D) 256
60. In humans, the Barr body is an
- (A) Active X chromosome in females
 - (B) Active X chromosome in males
 - (C) Inactive Y chromosome in males
 - (D) Inactive Y chromosome in females
 - (E) Inactive X chromosome in females
61. Which of the following statements about retrotransposons is correct?
- (A) They transpose via an RNA intermediate.
 - (B) They contain genes for ribosomal proteins.
 - (C) They possess a gene for RNA-dependent RNA polymerase.
 - (D) They possess genes that encode proteins that integrate RNA into chromosomes.
62. A mutation deleting an upstream activating sequence for a single gene would be expected to be
- (A) Polar
 - (B) Trans -dominant
 - (C) Cis -dominant
 - (D) Silent

SHORT ANSWER AND ESSAYS**DNA REPLICATION****1. Describe the mechanism of DNA replication in prokaryotes**

The three main phases of DNA replication in prokaryotes. The phases are: 1. Initiation 2. Elongation 3. Termination.

Phase # 1. Replication Initiation:

Replication initiation involves the following events:

- (1) Recognition of origin,
- (2) DNA melting, i.e., separation of the two strands in the origin region,
- (3) Stabilization of the single strands,
- (4) Assembly of primosome at the two forks so produced, and finally, and
- (5) Start of synthesis of the two daughter strands.

Replication initiation in *E. coli* requires 6 proteins, viz., DnaA, DnaB, DnaC, HU, gyrase and SSBP (single strand binding proteins). First, 2-4 molecules of DnaA bind oriC; this results in the folding of the origin *oriC* DNA around DnaA aggregate. As a result, DnaA now induces melting at *oriC*. Now an aggregate having 6 molecules each of DnaB and DnaC binds to each of the three separate single-stranded regions produced by DnaA.

The aggregate eventually displaces DnaA, and DnaC loads the DnaB hexamer at the two forks produced by melting. DnaB functions as helicase and begins to unwind the DNA. Gyrase facilitates unwinding by helicase as it provides a swivel. SSBP bind to the single-stranded regions so produced and stabilize them. Initiation of replication generally requires ~ 60 bp of unwound DNA, and the process consumes ATP. One DnaB hexamer binds to each of the two forks produced by unwinding at the origin (Fig. 28.10).

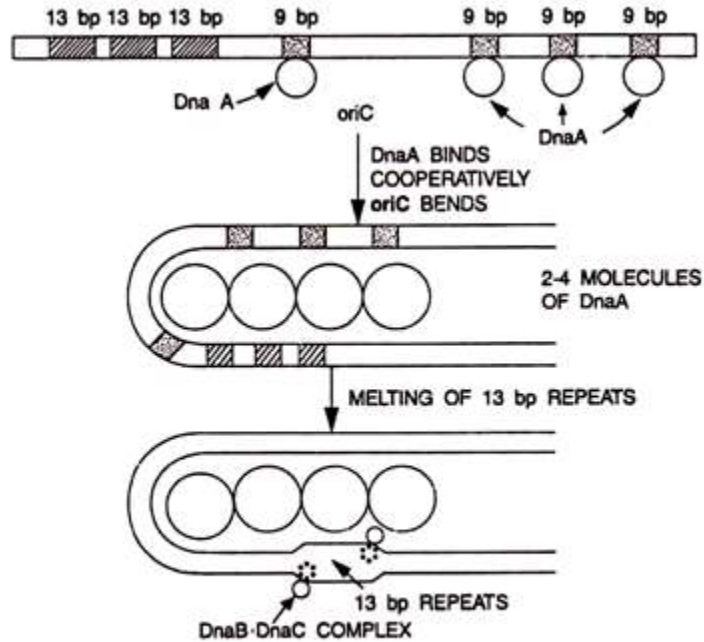

FIG. 28.10. In *E. coli*, replication initiation begins with binding of DnaA to *oriC*, which induces melting. DnaB (•••) then attaches to the potential forks and begins unwinding.

Once a replication fork is generated, primosome assembles at the origin, and initiates primer synthesis; this is called priming. Priming occurs only once and at the origin for the replication of the leading strand. But for replication of the lagging strand, priming occurs repeatedly at intervals of 1000 to 2000 bases.

Priming reaction at *oriC* is rather simple the primosome consists of a single protein, DnaG. DnaG needs to be activated by DnaB. DnaB also serves as helicase, while DnaG carries out primer synthesis; primers of 15-50 bases are normally synthesized.

The replication fork proceeds in the 5' → 3' direction in relation to the lagging strand. The replication fork advances and generates a single-stranded region of the lagging strand bound to SSBP ahead of the primosome. The primosome moves along this single-stranded region. When the primosome reaches a site at which priming can occur, it synthesizes an RNA primer. This primer sponsors synthesis of a new Okazaki fragment (Fig. 28.11).

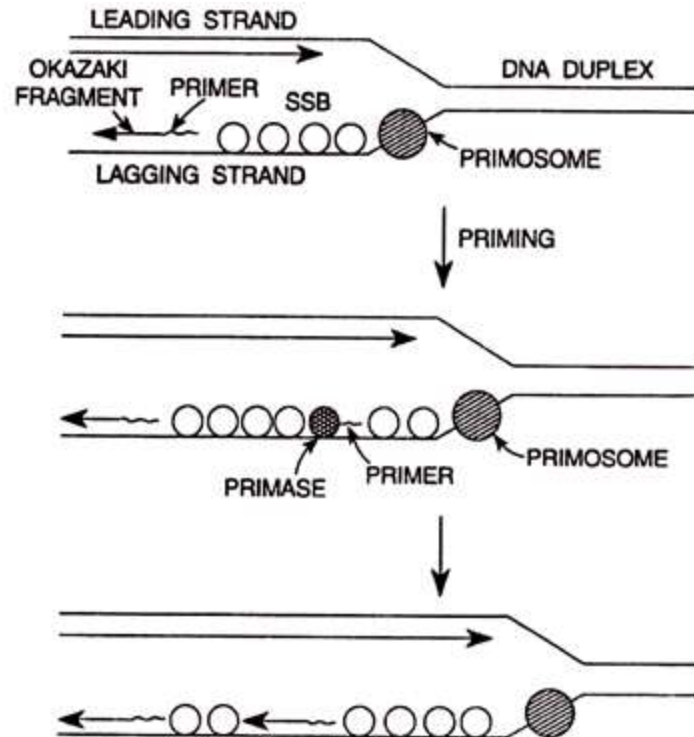

FIG. 28.11. A simplified schematic representation of the events involved in priming during replication of the lagging strand. Primosome may consist of simply DnaG at *oriC* or DnaG plus 5 other proteins in case of ϕ X type replicons.

Energy from ATP is required during:

- (1) Melting of DNA by DnaA,
- (2) Release of DnaB at the forks by DnaC,
- (3) Helicase action of DnaB,
- (4) Swivel action of DNA gyrase,
- (5) Activation of primase DnaG by DnaB, and
- (6) Activation of DNA polymerase III to begin replication.

Phase 2. Primer Elongation (DNA Replication):

Once the primer has been synthesized, DNA synthesis is taken up by replisome, which is a complex of proteins. In *E. coli*, DNA replication activity is provided by DNA polymerase III component of replisome.

Each *E. coli* cell has ~ 10 molecules of DNA polymerase III; most of these molecules are associated with replication forks. The complete enzyme, holoenzyme, molecule has the following subunits; α_2 , θ_2 , ϵ_2 , γ , ψ , δ , δ' , τ_2 , β_4 (Fig. 28.12).

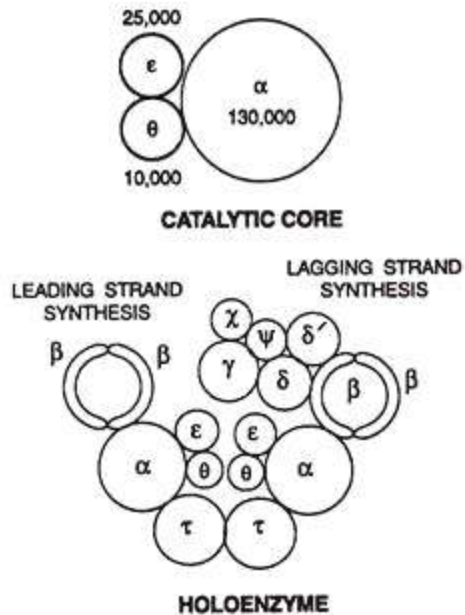

FIG. 28.12. A schematic representation of the organization of DNA polymerase III catalytic core and holoenzyme molecule.

The enzyme is assembled at the replication fork as follows:

1. First, the γ - δ complex (subunits γ δ δ' X ψ) or 'clamp loader' and a pair of β subunit (the 'clamp') recognize the primed-template and bind to it.
2. They now attach to a catalytic core (α θ ϵ subunits).
3. Subunit τ now joins the complex. It brings two more β subunits and another catalytic core to the complex. This generates a DNA polymerase III holoenzyme.

According to one model, a single holo-enzyme molecule functions at one replication fork. Each holoenzyme molecule has 2 catalytic cores; one catalytic core catalyzes the replication of leading strand, while the other catalyzes that of the lagging strand (Fig. 28.13).

In the case of leading strand, the catalytic core extends the primer one nucleotide at a time. DnaB progressively unwinds the duplex and the replication fork moves along.

Replication of the lagging strand will begin sometime later. When DnaB associated with the advancing fork reaches a site suitable for priming, it activates DnaG to synthesize a primer in the normal $5' \rightarrow 3'$ direction, i.e., moving from the fork toward the origin. When the primer become 10-14 bases long, the other catalytic core begins to elongate this primer in the $5' \rightarrow 3'$ direction.

The lagging strand, is in effect, pulled up by the replisome in the process of replication; it therefore, forms a progressively larger loop between the fork and the replisome (Fig. 28.13).

When the replisome reaches the 5'-end of the primer of the previous Okazaki fragment, it stops replication and dissociates from the lagging strand. Meanwhile DNAB continues to move forward with the replication fork. When it reaches the appropriate site, it again induces primer synthesis by DnaG and the events described above take place again.

In eukaryotes, two different enzymes are used to replicate the leading and the lagging strands. Leading strand is replicated by DNA polymerase δ , while replication of the lagging strand is due to DNA polymerase ϵ . Primase activity is due to DNA polymerase α , which primes both the leading and the lagging strands. It also begins to synthesize DNA using this primer, but is soon replaced by DNA polymerase δ (in the case of leading strand) and ϵ (in the case of lagging strand).

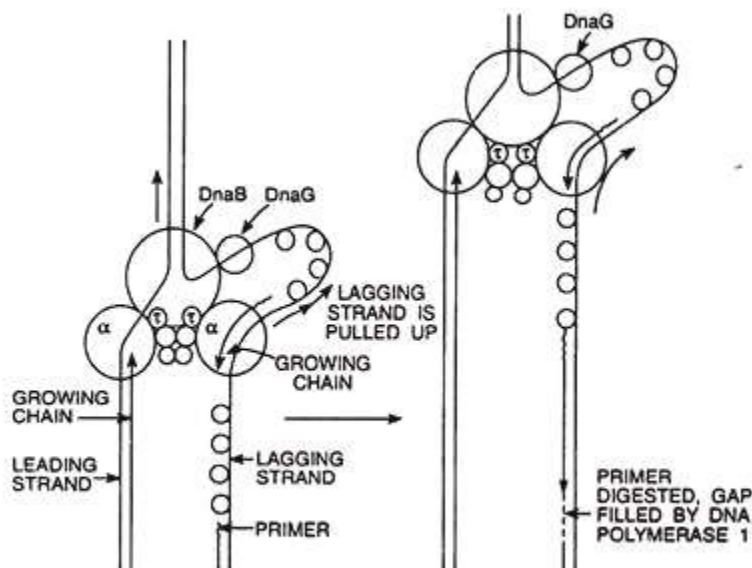

FIG. 28.13. Coordinated synthesis of leading and lagging strands by the same holoenzyme molecule of DNA polymerase III.

Phase # 3. Termination of DNA Replication:

In *E. coli*, termination is signalled by specific sequences called *ter* elements, which serve as a binding site for protein Tus. Tus protein binds to *ter* element and stops DnaB from unwinding DNA.

This stops the movement of the replication fork. The leading strand is replicated up to the *ter* element, while the lagging strand replication is stopped 50-100 bp before the *ter* element. It is significant that Tus protein is able to stop fork movement in only one direction.

ENZYMES INVOLVED IN DNA REPLICATION

2. Explain the role of enzymes involved in replication.

Both the prokaryotic and eukaryotic cells contain three types of nuclear enzymes that are essential for DNA replication. These enzymes are nucleases, polymerases and ligases.

(i) *Nucleases:*

The polynucleotide is held together by phosphodiester bonds. The nucleases hydrolyse the polynucleotide chain into the nucleotides. It attacks either at 3' OH end or 5' phosphate end of the chain. The nucleases are of two types (Fig. 5.17-B).

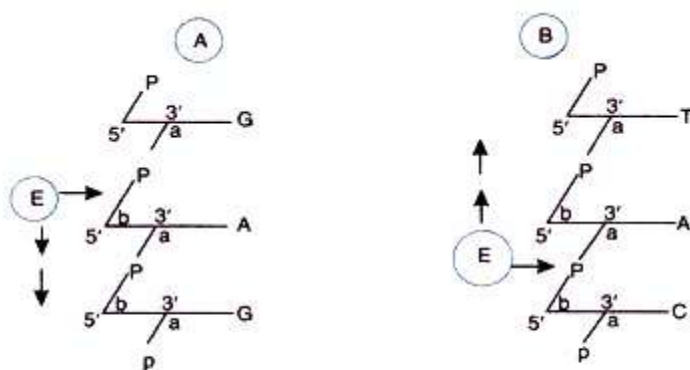

Fig. 5.17 : Exonuclease action on a polynucleotide chain. A, action in 5'→3' direction; B, action in 3'→5' direction; a 3' OH side of phosphodiester linkage; b, 5' side of phosphodiester linkage.

(a) *Exonucleases:*

The nuclease that attacks on outer free end of the polynucleotide chain is called exonuclease. It breaks phosphodiester bond either in direction (A) or in 3'→5' direction (B). The enzyme moves in either cases stepwise along the chain and removes nucleotides one by one. Thus, the whole chain is digested.

(b) *Endonucleases:*

The endonucleases attack within the inner portion of one or the double strands. Therefore, a nick is made on double stranded DNA molecule. However, if the polypeptide chain is single stranded (e.g. in DNA viruses), the attack of endonuclease will render the chain into two pieces.

On double stranded DNA the nick contains two free ends that in turn act as template for DNA replication. Apart from this, the nicked double helix is distorted due to rotation of free molecules around its intact strand.

(ii) DNA Polymerases:

DNA polymerases carry out the process of polymerization of nucleotides and formation of polynucleotide chain. This enzyme is called replicase when it replicates the DNA molecules and inherited by daughter cells. In 1959, for the first time A. Romberg discovered an enzyme in *E. coli* which polymerized the deoxyribonucleotide triphosphate on a DNA template and produced complementary strand of DNA.

This enzyme was called DNA polymerase. Later on it was named as Komberg polymerase or Romberg enzyme after the name of discoverer, for demonstrating in vitro polymerization of DNA. For the catalysis of polymerization, it requires the four deoxyribonucleotide triphosphates e.g. dATP, dGTP, dTTP and dCTP, a DNA template, a primer for initiation of catalytic activity and Mg^{++} (Fig. 5.18).

In prokaryotes, three types of DNA polymerases e.g. polymerase I (Poly-I), polymerase II (Pol II), and DNA polymerase III (Pol III) are found, whereas in eukaryotes three or four polymerases termed as α , β and γ polymerases and mitochondria (mt) DNA polymerase are present.

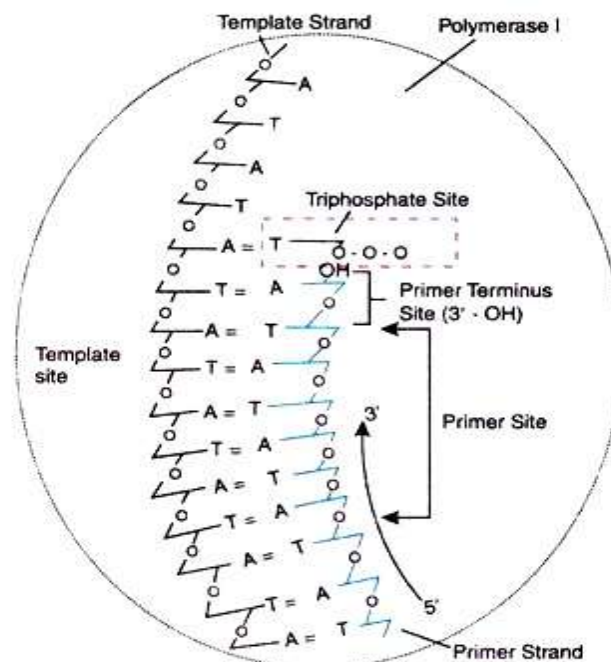

Fig. 5.18 : Diagram of DNA polymerase I of *E. coli*.

The molecular weight of α and γ polymerases are over 100,000 and that of β -polymerase is 30,000-50,000. The α and β polymerases are located in the nucleus. The β -polymerase copies a poly (A) or poly (C) template. The γ -polymerase copies many poly-ribonucleotides such as poly (A), poly (C), etc. The mtDNA polymerase is like γ -polymerase.

(a) Polymerase I (Pol I):

The Kornberg polymerase is known as Pol I. It is a single peptide chain with a molecular weight of 109,000 D. It is the largest single chain of globular protein known so far. One atom of zinc (Zn) per chain is present, therefore, it is metalloenzyme. In E. coli, approximately 400 molecules of Pol I are present.

Early experiments carried out by Kornberg revealed that when artificially synthesized DNA template strands alternating A and T i.e. poly d(AT) were incubated with polymerase and four radio- labelled nucleoside triphosphate, radioactive DNA containing alternating A and T was synthesized.

Though sufficient amount of dGTP and dCTP was present in the solution but these were not synthesized into DNA because the DNA strand contained only poly dAT. This emphasizes that Pol I synthesizes only complementary copy of the template.

Shape of Pol I has been studied through electron microscope. It is roughly spherical of about 65 Å diameters (Fig. 5.18) which gets attached regularly to the DNA chain.

Pol I possesses several attachment sites such as:

- (i) A template site for attachment to the DNA template,
- (ii) A primer site of about 100 nucleotides contemporary to a segment of RNA on which the growth of newly synthesized DNA occur,
- (iii) A primer terminus site containing a terminal 3'OH group at the tip, and
- (iv) A triphosphate site for matching the incoming nucleoside triphosphates according to complementary nucleotide of DNA template.

Function:

Pol I plays a significant role in polymerization (synthetic) as well as degradation (exonucleolytic) process of nucleotides, Pol I is broken by trypsin into two fragments, a large fragment (MW 75,000) and a small fragment (MW 36,000). The large fragment shows 3' → 5' exonuclease activity, and the small fragment shows 5' → 3' exonuclease activity. In E.coli the following three types of functions of Pol I have been found.

Polymerization:

Polymerization is a process of synthesis in $5' \rightarrow 3'$ direction of short segments of DNA chain from deoxyribonucleoside triphosphate monomers to the $3'$ -OH end of a DNA strand. It is not the main polymerization enzyme because it cannot synthesize a long chain. It synthesizes only a small segment of DNA.

It binds only to a DNA and forms nick in dsDNA. Therefore, it takes part in repair synthesis. In E.coli Pol I polymerize the nucleotides at the rate of 1,000 nucleotides per minute at 37°C . The chief enzyme associated with polymerization is known as polymerase III.

Exonuclease activity: **$3' \rightarrow 5'$ exonuclease activity:**

Pol I catalyses the breaking of one or two DNA strands in $3' \rightarrow 5'$ direction into the nucleotide components i.e. the nucleotides are set free in $3' \rightarrow 5'$ direction which is reverse to polymerization direction.

Therefore, it is called $3' \rightarrow 5'$ exonuclease activity. Pol I correct the errors made during the polymerization, and edits the mismatching nucleotides at the primer terminus before the start of strand synthesis. Therefore, the function of Pol I is termed as repair synthesis.

 $5' \rightarrow 3'$ exonuclease activity:

Pol I also breaks the polynucleotide chain in $5' \rightarrow 3'$ direction with the removal of nucleotide residues. Upon exposure of DNA to the ultraviolet light two adjacent pyrimidines such as thymines are covalently linked forming pyrimidine dimers. These dimers block the replication of DNA. Therefore, removal of pyrimidine dimers e.g. thymine dimers (T=T) is necessary.

Through $5' \rightarrow 3'$ exonuclease activity, Pol I removes pyrimidine dimers. Secondly, DNA synthesis occurs on RNA primer in the form Okazaki fragments. Through $5' \rightarrow 3'$ exonuclease activity Pol I remove RNA primer and seal the gap with deoxyribonucleotides. Its onward movement results in removal of ribonucleotides from the front portion followed by of deoxyribonucleotides behind it.

(b) Polymerase II (Pol II):

For several years Pol I was considered to be responsible for replicating in E.coli. but the work done during 1970s made it clear that Pol I is associated only with repair synthesis and the other enzymes, Pol II and Pol III are involved in polymerization process. Pol II is a single

polypeptide chain (MW 90,000) that shows polymerization in $5' \rightarrow 3'$ direction of a complementary chain.

It also shows exonuclease activity in $3' \rightarrow 5'$ direction but not in $5' \rightarrow 3'$ direction. The polymerization activity of Pol II is much less than Pol I in E.coli cells. About 50 nucleotides per minute are synthesized. E.coli cells contain about 40 Pol II molecules.

The $3' \rightarrow 5'$ exonuclease activity of Pol II shows that it also plays a role in repair synthesis or DNA damaged by U.V. light just like Pol I. In the absence of Pol I, it can elongate the Okazaki fragments. Therefore, Pol II is an alternative to Pol I.

(c) Polymerase III (Pol III):

DNA polymerase III is several times more active than Pol I and Pol II enzymes. It is the dimer of two polypeptide chains with molecular weight 1,40,000 and 40,000 D respectively. Pol III polymerises deoxyribonucleoside triphosphates in direction very efficiently. Therefore, Pol III is the main polymerization enzyme that can polymerize about 15,000 nucleotides per minutes in E. coll.

Like Pol II, it cannot polymerize efficiently if the template DNA is too long but can do when ATP and certain protein factors are present. Synthesis of a long template also occurs when an auxiliary protein DNA (co-polymerase II) is linked with Pol III and produced Pol III-co Pol II complex. In addition Pol III also shows $3' \rightarrow 5'$ exonuclease activity like Pol II.

The $5' \rightarrow 3'$ exonuclease activity is absent. All the polymerases e.g. Pol I, Pol II and Pol III show $3' \rightarrow 5'$ exonuclease activity, whereas besides Pol I, the other two polymerases (Pol I and Pol II) lack $5' \rightarrow 3'$ exonuclease activity. However, some workers have shown both $3' \rightarrow 5'$ and $5' \rightarrow 3'$ exonuclease activity in Pol III.

(iii) DNA Ligases:

The DNA ligases seal single strand nicks in DNA which has $5' \rightarrow 3'$ termini. It catalyses the formation of phosphodiester bonds between $3'$ -OH and $5'$ - PO_4 group of a nick, and turns into an intact DNA. There are two types of DNA ligases: E. coli DNA ligase and T4 DNA ligase. The E. coli DNA ligase requires nicotinamide adenine dinucleotide (NAD^+) as cofactor, whereas T4 DNA ligase uses ATP as cofactor for joining reaction of the nick (Fig 5.19).

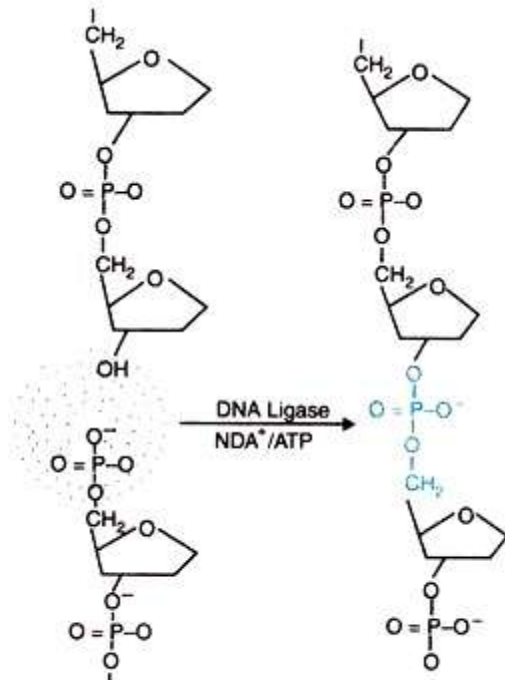

Fig. 5.19 : Action of DNA ligase in the presence of NAD⁺/ATP.

MECHANISM OF TRANSCRIPTION IN PROKARYOTES

3. Explain the process of Transcription with the help of a labelled diagram

Genetic DNA is confined to the nucleus. Since it is a macro molecule the nucleus membrane is impermeable. Hence DNA acts as the template for the synthesis of mRNA chain. Unwinding of the chain takes place by the enzyme unwindase. One of the chains becomes template for the synthesis of mRNA chain. This strand is called anti sense strand.

The strand complementary to this strand is called sense strand. mRNA synthesis takes place on the sense strand. The nucleotide sequences of DNA are coded on the mRNA is called transcription. mRNA synthesised is complimentary to DNA transcribed. Enzyme RNA polymerase polymerise s RNA nucleotides. Rewinding of DNA strands takes place by windase

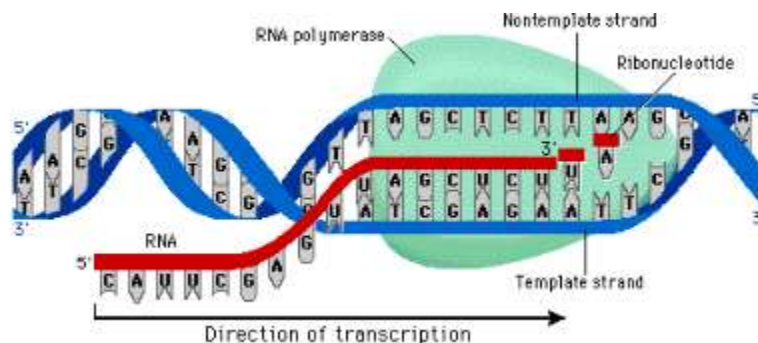

4. Write a note on Inhibitors of Transcription

• Rifampicin- binds with Beta subunit of prokaryotic RNA polymerase, • It is an inhibitor of prokaryotic transcription initiation. • It binds only to bacterial RNA polymerase but not to eukaryotic RNA polymerases. • Therefore, Rifampicin is a powerful drug for treatment of bacterial infections. • Used for the treatment of tuberculosis and leprosy

5. Write the Mechanism of action of Actinomycin

Mechanism of action of Actinomycin D • Actinomycin D- Intercalates with DNA strands • Actinomycins inhibit both DNA synthesis and RNA synthesis by blocking chain elongation. • They interact with G·C base pairs as they require the 2-amino group of guanine for binding. • Actinomycins are used as anticancer drugs

Mitomycin • Mitomycin- Intercalates with DNA strands • blocks transcription, • used as anticancer drug

Alpha amanitin • Alpha amanitin is a molecule made from the “death cap” mushroom and is a known potent inhibitor RNA polymerase. • One single mushroom could very easily lead to a fast death in 10 days. • The mechanism of action is that alpha amanitin inhibits RNA polymerase –II at both the initiation and elongation states of transcription.

DIFFERENCES BETWEEN DNA AND RNA**6. List five differences between DNA and RNA**

DNA	RNA
• Mostly double stranded	Single stranded, except in some viruses
• Nucleotides are AGCT	Nucleotides are AGCU
• Pentose sugar is deoxy ribose	Pentose sugar is ribose
• It acts as the template for Transcription.	It involves in protein synthesis
• Types of DNA co - exist in a DNA molecule	There are three types mRNA, tRNA, rRNA
• It is hereditary material	Only in RNA viruses it is genetic material
• It is self replicating	RNA synthesis takes on DNA template
• It directs protein synthesis	Directly produced proteins .
• It can produce RNA	It generally does not produce DNA

POST TRANSCRIPTIONAL PROCESSING OF RNA**7. Explain Modifications of primary transcript in prokaryotes**

- In prokaryotic organisms, the primary transcripts of mRNA-encoding genes begin to serve as translation templates even before their transcription has been completed.
- This is because the site of transcription is not compartmentalized into a nucleus as it is in eukaryotic organisms.
- Consequently, prokaryotic mRNAs are subjected to little processing prior to carrying out their intended function in protein synthesis
- Transcription and translation are coupled in prokaryotic cells.

8. Describe Post Transcriptional modifications in Eukaryotes

- All eukaryotic RNA primary transcripts undergo extensive processing whether it be as mRNA or as a component of the translation machinery such as rRNA, 5S RNA, or tRNA or RNA processing machinery, snRNAs.
- Processing occurs primarily within the nucleus and includes nucleolytic cleavage to smaller molecules and coupled nucleolytic and ligation reactions (splicing of exons).
- The processes of transcription, RNA processing, and even RNA transport from the nucleus are highly coordinated.

9. Briefly explain Processes involved in the post transcriptional modifications

- Some of the processes involved in the post transcriptional modifications of primary transcript of major RNAs are as follows- A) Ribosomal RNA • In mammalian cells, the three rRNA molecules are transcribed as part of a single large precursor molecules called Pre ribosomal RNAs

10. Describe Post Transcriptional modifications of Ribosomal RNA(r- RNA)

- The precursor is subsequently processed in the nucleolus to provide the RNA component for the ribosome subunits found in the cytoplasm.
- The 23S,16S, and 5S ribosomal RNAs of prokaryotes are produced from a single RNA precursor molecule as are the 28S, 18S and 5.8S r RNAs of eukaryotes.
- Eukaryotic 5S rRNA in eukaryotes is synthesized by RNA polymerase III and modified separately.

The 23S, 16S, and 5S ribosomal RNAs of prokaryotes are produced from a single RNA precursor molecule. • Cleavage and trimming are the mechanisms involved, • Similar modifications are observed in the processing of eukaryotic r-RNA.

11. Describe Post Transcriptional modifications of Transfer RNA (t- RNA)

The tRNA molecules serve as adapter molecules for the translation of mRNA into protein sequences. • Both eukaryotic and prokaryotic transfer RNAs are made from longer precursor molecules that must be modified. • The basic mechanisms involved are as follows. Splicing- An intron must be removed from the anticodon loop • Trimming- The sequences at both the 5' and 3' ends of the molecule are trimmed • Base modifications- The tRNAs contain many modifications of the standard bases A, U, G, and C, including methylation, reduction, deamination, and rearranged glycosidic bonds. Further modification of the tRNA molecules includes nucleotide alkylations.

CCA attachment • The attachment of the characteristic CpCpAOH terminal at the 3' end of the molecule by the enzyme nucleotidyl transferase is the most important modification.

• The 3' OH of the A ribose is the point of attachment for the specific amino acid that is to enter into the polymerization reaction of protein synthesis.

The extra nucleotides at both 5' and 3' ends of t- RNA are removed, an intron from the anticodon arm is removed, bases are modified and CCA arm is attached to form the mature functional t RNA.

12. Explain Post Transcriptional modifications of pre m- RNA

• In prokaryotic organisms, the primary transcripts of mRNA-encoding genes begin to serve as translation templates even before their transcription has been completed. • In all eukaryotes the primary transcripts of mRNA-encoding genes undergo extensive processing before they are converted to mature functional forms

5' Capping • Mammalian mRNA molecules contain a 7- methylguanosine cap structure at their 5' terminal. • The cap structure is added to the 5' end of the newly transcribed mRNA precursor in the nucleus prior to transport of the mRNA molecule to the cytoplasm. • The 5' cap of the RNA transcript is required both for efficient translation initiation and protection of the 5' end of mRNA from attack by 5'-3' exonucleases. • Eukaryotic m RNAs lacking the cap are not efficiently translated.

- The addition of the Guanosine triphosphate (part of the cap is catalyzed by the nuclear enzyme guanylyl transferase.
- Methylation of the terminal guanine occurs in the cytoplasm. and is catalyzed by guanine-7- methyl transferase.
- S-Adenosyl methionine is the methyl group donor.
- Additional methylation steps may occur. The secondary methylations of mRNA molecules, those on the 2'-hydroxy and the •N6 of adenylyl residues, occur after the mRNA molecule has appeared in the cytoplasm.

Addition of poly A tail

- Poly(A) tails are added to the 3' end of mRNA molecules in a posttranscriptional processing step.
- The mRNA is first cleaved about 20 nucleotides downstream from an AAUAA recognition sequence
- Another enzyme, poly(A) polymerase, adds a poly(A) tail which is subsequently extended to as many as 200 A residues.
- The poly (A) tail appears to protect the 3' end of mRNA from 3' 5' exonuclease attack.
- Histone and interferon's mRNAs lack poly A tail.
- After the m-RNA enters the cytosol, the poly A tail is gradually shortened.

MECHANISM OF SPLICING

13. Explain the mechanism of Splicing

- Introns or intervening sequences are the RNA sequences which do not code for the proteins.
- These introns are removed from the primary transcript in the nucleus, exons (coding sequences) are ligated to form the mRNA molecule, and the mRNA molecule is transported to the cytoplasm.

Role of small nuclear RNA (sn RNA) and Spliceosome

- The molecular machine that accomplishes the task of splicing is known as the spliceosome. Spliceosomes consist of the primary transcript, five small nuclear RNAs (U1, U2, U4, U5, and U6) and more than 60 proteins.

- Collectively, these form a small ribonucleoprotein (snRNP) complex, sometimes called a "snurp" (snRNPs)

Snurps are thought to position the RNA segments for the necessary splicing reactions.

- These facilitate the splicing of exon segments by forming base pairs with the consensus sequence at each end of the intron.

Splicing of m-RNA

- The newly- feed 3'OH of the upstream exon 1 then forms a phosphodiester bond with the 5'end of the downstream exon 2.
- The excised intron is released as a "lariat"

structure, which is degraded • After removal of all the introns, the mature m RNA molecules leave the nucleus by passing in to the cytosol through pores in to the nuclear membrane.

14. Give the Clinical significance of Splicing

Antibodies against snRNPs In systemic Lupus Erythematosus (SLE), an auto immune disease, the antibodies are produced against host proteins, including sn RNPs.

Clinical significance of Splicing 2) Mutations at the splice site • Mutations at the splice site can lead to improper splicing and the production of aberrant proteins . • For example some cases of Beta thalassemia are as a result of incorrect splicing of beta globin m-RNA due to mutation at the splice site.

15. Explain Alternative Splicing

• Alternative patterns of RNA splicing is adapted for the synthesis of tissue-specific proteins. • The pre-m RNA molecules from some genes can be spliced in two or more alternative ways in different tissues. • This produces multiple variations of the m RNA and thus diverse set of proteins can be synthesized from a given set of genes.

Tissue specific tropomyosins are produced from the same primary transcript by alternative splicing. • Alternative splicing and processing results in the formation of seven unique α - tropomyosin mRNAs in seven different tissues

Biological significance of Splicing • Tissue specific proteins are produced from the same primary transcript by alternative splicing

16. Explain the Biological significance of Splicing

• Similarly, the use of alternative termination- cleavage-polyadenylation sites also results in mRNA variability . • Alternative polyadenylation sites in the immunoglobulin heavy chain primary transcript result in mRNAs that are either 2700 bases long (m) or 2400 bases long (s). • This results in a different carboxyl terminal region of the encoded proteins such that the m protein remains attached to the membrane of the B lymphocyte and the s immunoglobulin is secreted.

Biological significance of Splicing • By means of alternative poly A sites variability in mRNA can be produced and thus different proteins can be synthesized from a given set of genes

17. Give the characteristic of a eukaryotic enhancer element?

- (A) Its activity is independent of its orientation (i.e., the sequence can be inverted without effect).
- (B) Its activity is dependent on its distance from the start site of transcription.
- (C) It may be found as far as 1 to 2 kilobases from the promoter.
- (D) It may be positioned at the 5' end or the 3' end of the gene.
- (E) It increases the level of transcription of genes under its control.

18. Write a short note on repetitive DNA.

- (A) Repetitive DNA is associated with the centromeres and telomeres in higher eukaryotes.
- (B) Repetitive DNA is restricted to nontranscribed regions of the genome.
- (C) Repetitive DNA sequences are often found in tandem clusters throughout the genome.
- (D) Repetitive DNA was first detected because of its rapid reassociation kinetics.
- (E) Transposable elements can contribute to the repetitive DNA fraction.

GENETIC CODE & TRANSLATION**19. Explain the Characteristics of genetic code.**

Triplet code; the genetic code is a triplet code.

It means that three nucleotides of DNA code for one amino acid. eg : AUG.

The genetic code is universal; It means that a particular mRNA codon codes for the specific amino acid in all living organisms.

Genetic code is degenerate or redundant; some of the amino acids are coded by two or more codons

These redundant codons codes for the same amino acids are called degenerate codons.

eg : Valine has four codons GUG ,GUU, GUC,GUA

Genetic code is non overlapping; In this property the base of the one codon is not shared by the neighbouring codon

Genetic code is comma less ;

Genetic code has no punctuation mark inside the message.

AUG is the initiator codon.

UAA UGA UAG is terminator codons

20. Describe the Mechanisms of Protein Synthesis:

In prokaryotes, the RNA synthesis (transcription) and protein synthesis (translation) take place in the same compartment as there is no separate nucleus. But in eukaryotes, the RNA synthesis takes place in the nucleus while the protein synthesis takes place in the cytoplasm. The mRNA synthesized in the nucleus is exported to cytoplasm through nucleopores.

First, Francis Crick in 1955 suggested and later Zamecnik proved that prior to their incorporation into polypeptides, the amino acids attach to a special adaptor molecule called tRNA. This tRNA has a three nucleotide long anticodon which recognizes three nucleotide long codon on mRNA.

Role of Ribosomes in Protein synthesis:

Ribosome is a macromolecular structure that directs the synthesis of proteins. A ribosome is a multicomponent, compact, ribonucleoprotein particle which contains rRNA, many proteins and enzymes needed for protein synthesis. Ribosome brings together a single mRNA molecule and tRNAs charged with amino acids in a proper orientation so that the base sequence of mRNA molecule is translated into amino acid sequence of polypeptides.

Ribosome is a nucleoprotein particle having two subunits. These two subunits lie separately but come together for the synthesis of polypeptide chain. In *E. coli* ribosome is a 70S particle having two subunits of 30S and 50S. Their association and dissociation depends upon the concentration of magnesium.

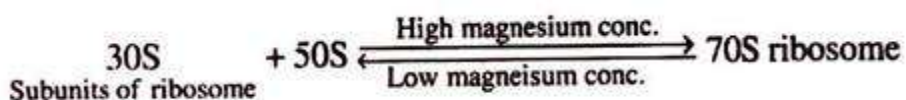

Small subunit of ribosome contains the decoding centre in which charged tRNAs decode the codons of mRNA. Large subunit contains peptidyl transferase centre, which forms the peptide bonds between successive amino acids of the newly synthesized peptide chain.

Both 30S and 50S subunits consist of ribosomal RNA (rRNA) and proteins.

The mRNA binds to the 16S rRNA of smaller subunit. Near its 5'-end mRNA binds to the 3'-end of 16S rRNA.

The main role of ribosome is the formation of peptide bond between successive amino acids of the newly synthesized polypeptide chain. The ribosome has two channels in it. The linear mRNA enters and escapes through one channel, which has the decoding centre. This channel is

accessible to the charged tRNAs. The newly synthesized polypeptide chain escapes through the other channel.

Direction of Translation:

Each protein molecule has an $-NH_2$ end and $-COOH$ end. Synthesis begins at amino end and ends at carboxyl end. The mRNA is translated in $5 \rightarrow 3'$ direction from amino to carboxyl end. Synthesis of mRNA from DNA transcription also occurs in $5' \rightarrow 3'$ direction.

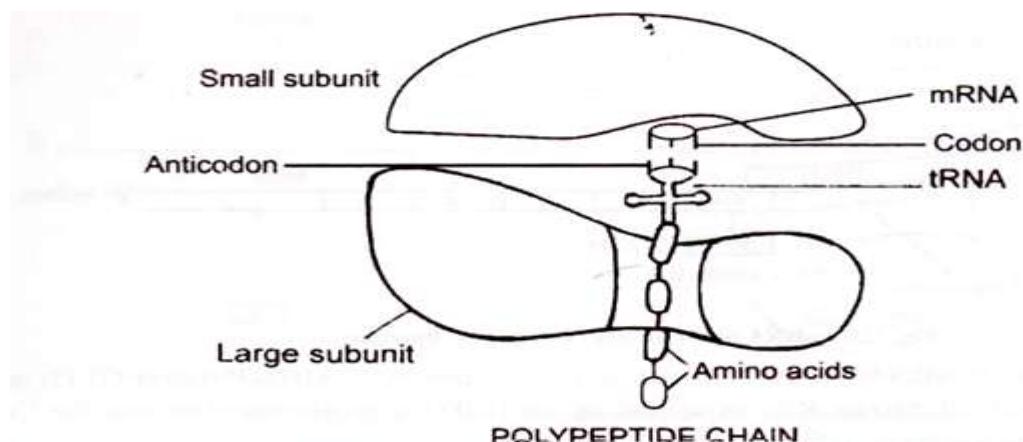

Fig. 12.1. Ribosome showing two subunits and position of mRNA and tRNA. The nascent polypeptide chain passes through a channel.

Initiation of Protein Synthesis:

Formation of Initiation Complex:

First of all 30S subunit of the 70S ribosome starts initiation process. The 30S subunit, mRNA and charged tRNA combine to form pre-initiation complex. Formation of pre-initiation complex involves three initiation factors IF1, IF2 and IF3 along with GTP (guanosine triphosphate). Later 50S subunit of ribosome joins 30S subunit to form 70S initiation complex.

Information for protein synthesis is present in the form of three nucleotide codons on mRNA. Protein coding regions on mRNA consist of continuous, non-overlapping triplet codons. The protein coding region on mRNA is called open reading frame which has a start codon $5'-AUG-3'$ and a stop codon in the end. Each open reading frame specifies a single protein. Prokaryote mRNA has many open reading frames, therefore encode multiple polypeptides and are called polycistronic mRNAs.

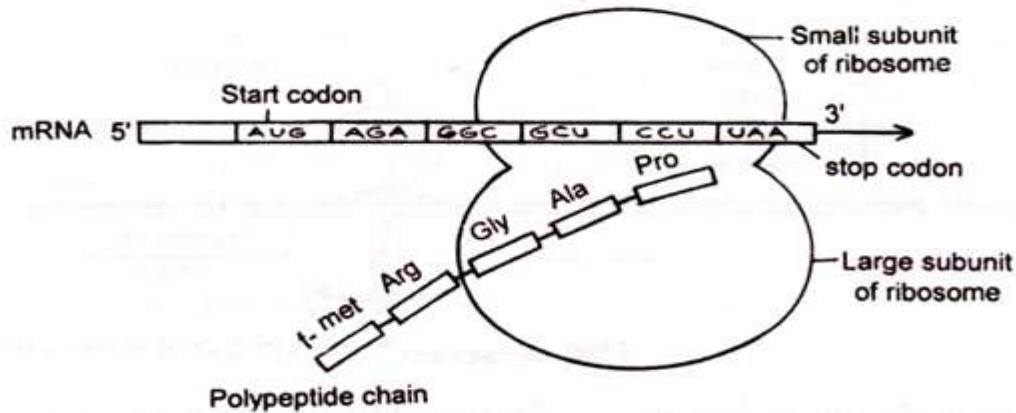

Fig. 12.2. A ribosome translates an mRNA molecule.

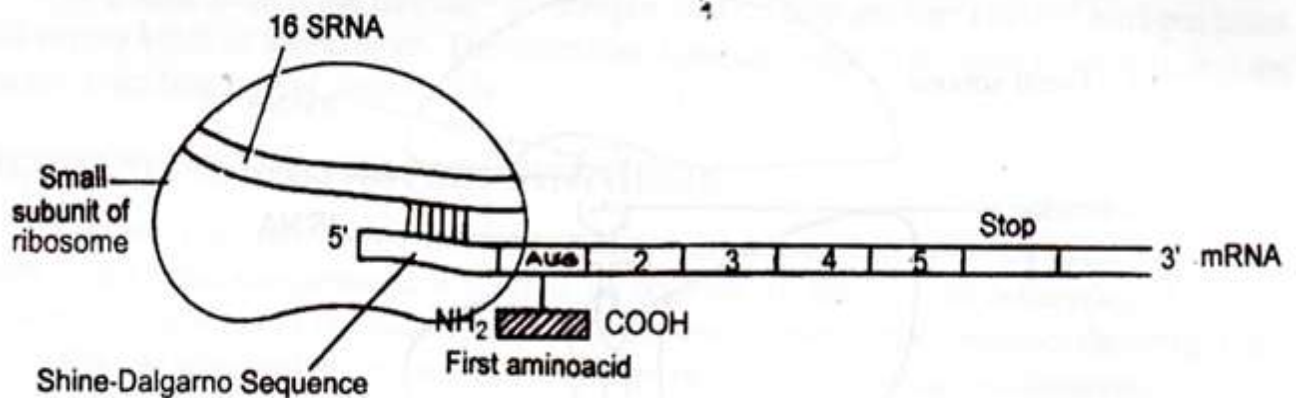

Fig. 12.3. mRNA binds to small subunit of ribosome.

Near the 5'-end of mRNA lies the start codon which is mostly 5'-AUG-3' (rarely GUG) in both prokaryotes and eukaryotes. Ribosome binding site (RBS) in prokaryotes lies near the 5'- end of mRNA ahead (upstream) of AUG codon.

Between 5'-end and AUG codon there is a sequence of 20-30 bases. Of these, there is a sequence 5'-AGGAGGU-3'. This purine rich sequence is called Shine-Dalgarno sequence and lies 4-7 bases ahead (upstream) of AUG codon.

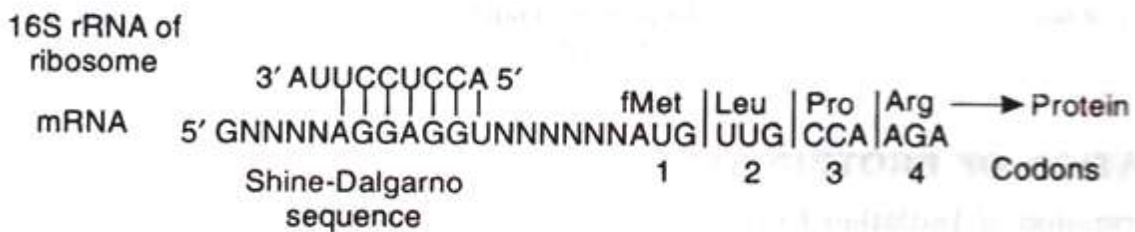
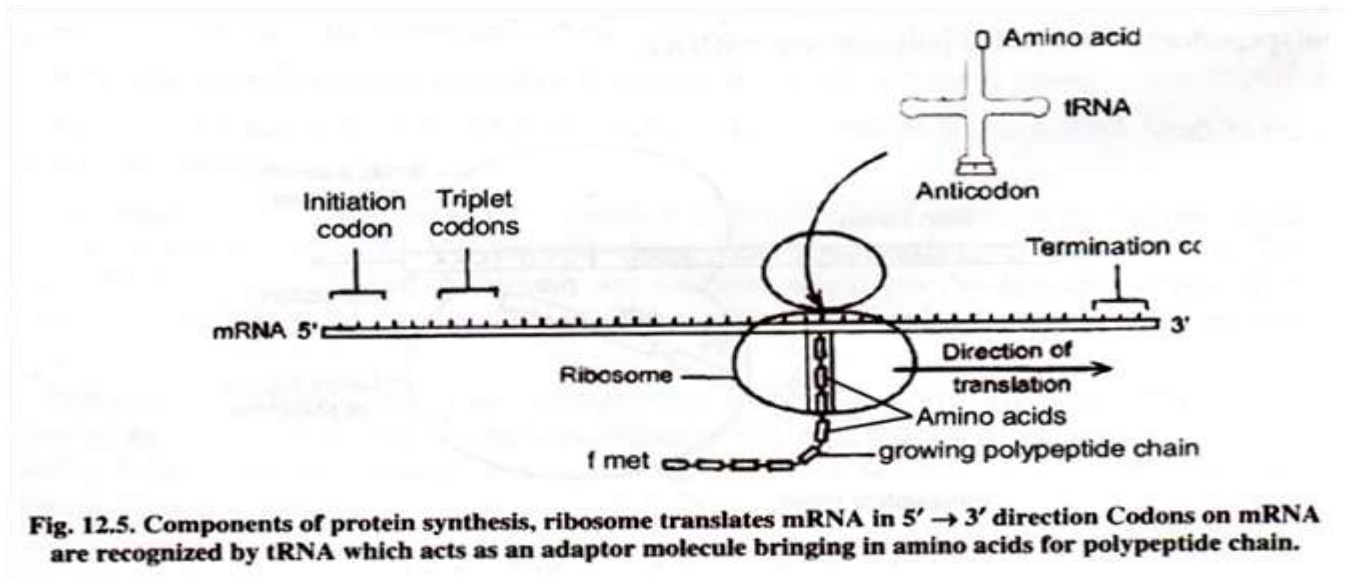
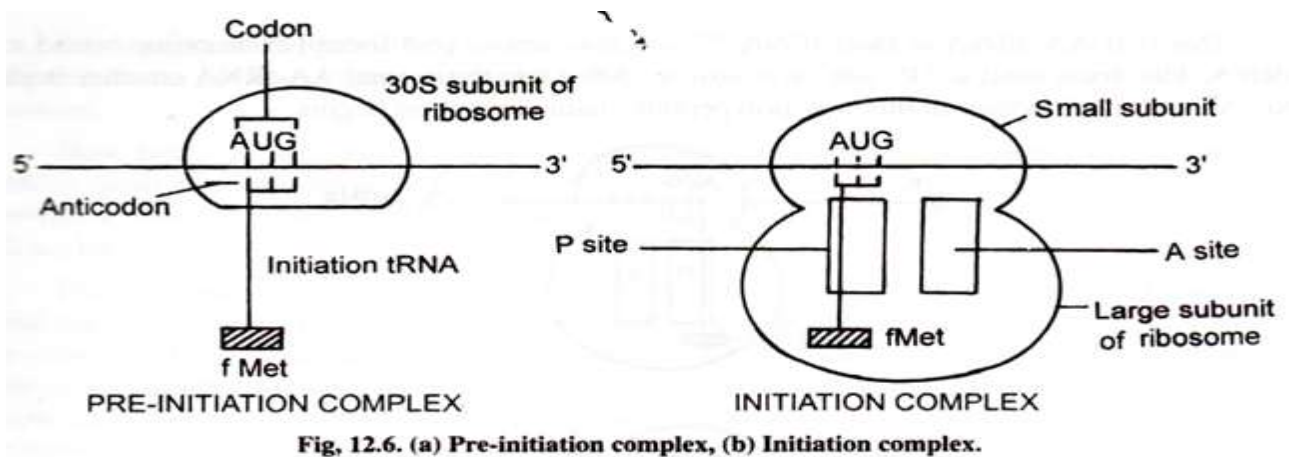

Fig. 12.4.

The 3'-end region of 16S rRNA in 30S subunit has a complementary sequence 3'-AUUCCUCCA-5'. This sequence forms base pairs with Shine-Dalgarno sequence for binding of mRNA to ribosome. Shine-Dalgarno sequence is the ribosome binding site (RBS). It positions the ribosome correctly with respect to the start codon.



There are two tRNA binding sites on ribosome covering 30S and 50S subunits. The first site is called “P” site or peptidyl site. The second site is called “A” site or aminoacyl site. Only the initiator tRNA enters the “P” site. All other tRNAs enter the “A” site.



For every amino acid, there is a separate tRNA. The identity of a tRNA is indicated by superscript, such as tRNA^{Arg} (specific for amino acid Arginine). When this tRNA is charged with amino acid Arginine, it is written as Arginine- tRNA^{Arg} or $\text{Arg-tRNA}^{\text{Arg}}$. Charged tRNA is called aminoacylated tRNA.

In bacteria, the first amino acid starting the protein is always formyl methionine (fMet). When AUG appears as the start codon on mRNA only fMet is incorporated. The tRNA molecule carrying formyl methionine is called tRNA^{fMet}. Therefore the first initiator charged aminoacyl tRNA is always fMet-tRNA^{fMet}. When AUG codon is encountered in the internal location (other than the start codon), methionine is not formylated and tRNA carrying this methionine is tRNA_m^{Met}.

First of all the charged initiator tRNA called tMet-tRNA^{fMet} occupies the “P” site on ribosome. This position brings its anticodon and start codon AUG of mRNA together in such a way that the anticodon of charged tRNA and codon of mRNA form base pair with each other. Thus reading or translation of mRNA begins.

The “A” site is available to the second incoming charged tRNA whose anticodon forms base pairs with the second codon on mRNA.

Charging of tRNA:

Attachment of amino acids to tRNAs is called charging of tRNA. All tRNAs at their 3'-terminus have a sequence 5'-CCA-3'. At this site amino acids bind with the help of enzyme aminoacyl tRNA synthetase. Charging of tRNA occurs in two steps.

1. Activation of amino acids:

Energy molecule ATP activates the amino acids. This step is catalysed by specific activating enzymes called aminoacyl tRNA synthetases. Every amino acid has a separate enzyme AA-RNA synthetase enzyme.

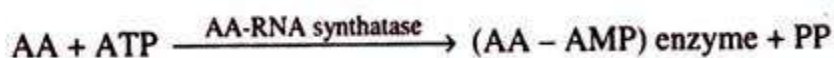

2. Transfer of amino acids to tRNA:

AA-AMP enzyme complex reacts with a specific tRNA and transfers the amino acid to tRNA, as a result of which AMP and enzyme are set free.



This first AA-tRNA is fMet-tRNA^{fMet} which is amino acid formyl methionine bound to tRNA. This fixes itself to “P” site on ribosome. After this the second AA-tRNA attaches itself to “A” site on ribosome. In this way polypeptide chain elongation begins.

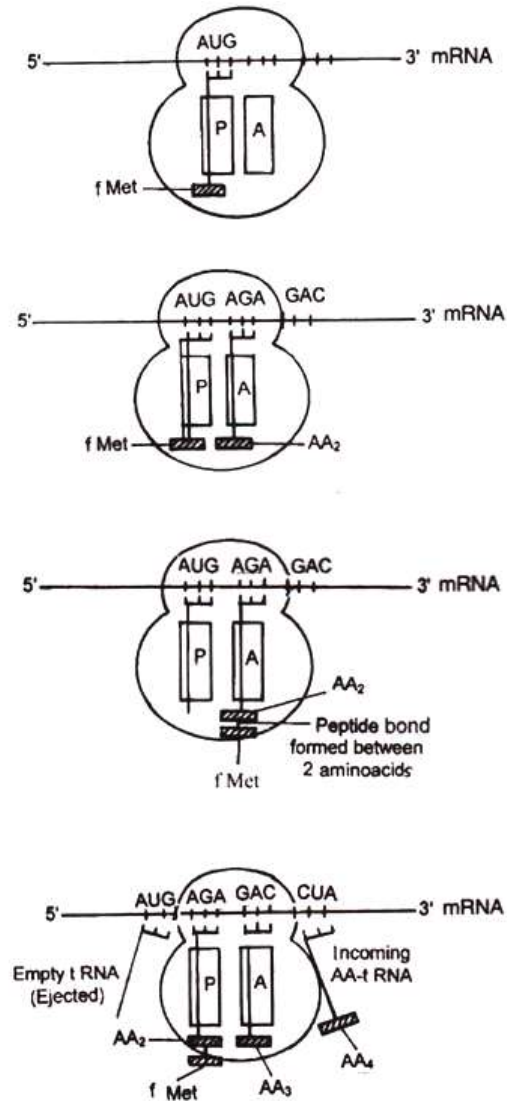

Fig. 12.7. Polypeptide chain formation, binding of charged tRNA, Peptide bond formation, and translocation.

Polypeptide Chain Elongation:

Polypeptide chain elongation requires some elongation factors. These elongation factors are Tu and G.

EF-Tu forms a complex with AA₂-tRNA and GTP and brings it to the “A” site of ribosome. Once the AA₂-tRNA is in place at “A” site, the GTP is hydrolysed to GDP and EF-Tu is released from the ribosome. EF-Tu-GTP complex is regenerated with the help of another factor Ts.

Formation of Peptide Bond:

The main role of ribosome is to catalyse the formation of peptide bonds between successive amino acids. In this way amino acids are incorporated into protein.

Now both “P” site and “A” site on ribosome are occupied by charged tRNAs having amino acids. Peptide bond is formed between two successive amino acids at “A” site. It involves cleavage of bond between f-Met and tRNA. This is catalysed by the enzyme tRNA deacylase. Peptide bond is formed between the free carboxyl group (-COOH) of the first amino acid and the free amino group (-NH₂) of the second amino acid at the “A” site. The enzyme involved in this reaction is peptidyl transferase. After the formation of peptide bond, between two amino acids, the tRNA at “P” site becomes uncharged or deacylated and tRNA at “A” site now carries a – ill protein chain having two amino acids. This occurs in 50S subunit of ribosome.

The peptidyltransferase which catalyzes the peptide bond formation between successive amino acids consists of several proteins and molecule of 23S rRNA in the ribosome. This 23S rRNA is a ribozyme.

Translocation:

The peptidyl tRNA carrying two amino acids present at “A” site is now translocated to “P” site. This movement is called translocation. Elongation factor called EF-G control translocation. This factor G is called translocase. Hydrolysis of GTP provides energy for translocation and release of deacylated tRNA (free of amino acid).

Translocation also involves movement of ribosome along mRNA towards its 3'-end by a distance of one codon from first to second codon. This movement shifts the dipeptidyl tRNA (carrying two amino acids) from “A” to “P” site.

In addition to these two sites P and A, a third site “E” (exit site) on 50 S ribosome is present. Deacylated tRNA (deprived of amino acid) moves for “P” site to “E” site from where it is ejected out.

Then the third amino acid (next amino acid) charged on tRNA comes to lie in now empty site “A”. Then dipeptidyl chain having two amino acids present on P site form peptide bond with the third amino acid at “A” site. Then the three amino acid chain is translocated to “P” site. Now the polypeptide chain has three amino acids. This elongation process goes on and on. At each step a new amino acid is added to the polypeptide chain. After each elongation, ribosome moves by one codon in 5' → 3' direction.

Chain Termination:

The presence of termination codons or stop codons on mRNA causes the polypeptide chain to be terminated. Synthesis stops when elongation chain comes across stop codons on “A” site. The stop codons are UAA, UGA and UAG. There is no tRNA which can bind these codons.

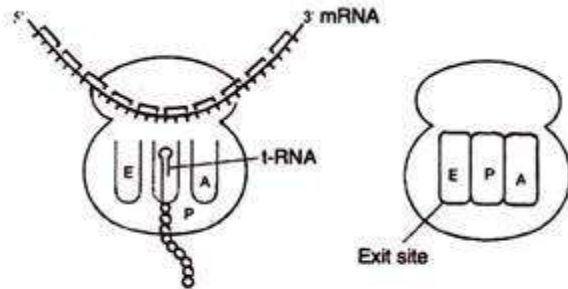

Fig. 12.8.

There are three release factors in prokaryotes, which help in chain termination. They are RF1, RF2 and RF3.

Polyribosome or Polysome:

A single mRNA molecule can be read simultaneously by several ribosomes. A polyribosome or polysome consists of several ribosomes attached to the same RNA. The number of ribosomes in a polysome depends upon the length of mRNA.

A fully active mRNA has one ribosome after every 80 nucleotides. There may be about 50 ribosomes in a polycistronic mRNA of prokaryotes. Ribosomes move along mRNA in 5' 3' direction. There is a gradual increase in the size of polypeptide chain as the ribosomes move along mRNA towards its 3'-end. Polypeptide chain starts near the 5'-end and is completed near the 3'-end.

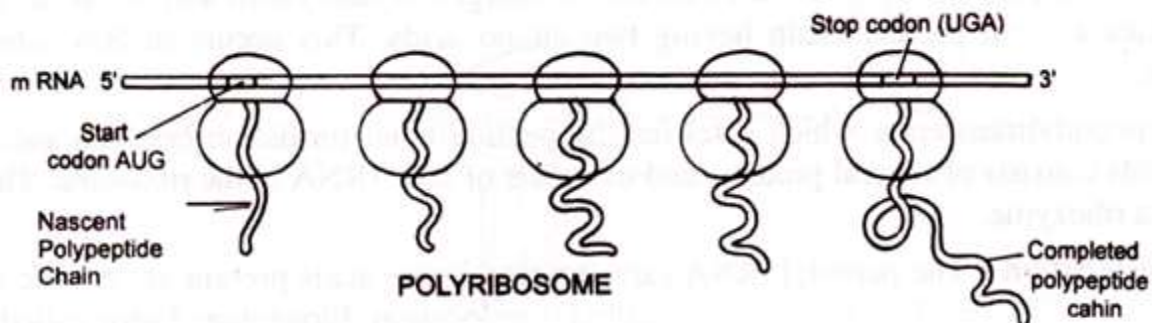

Fig. 12.9. Polyribosome

The ribosomes closest to the 5'-end of mRNA have the smallest polypeptide chain, while ribosomes nearest to the 3'-end have longest chain. Polysome increases the rate of protein synthesis tremendously. In bacteria protein is synthesized at the rate of about 20 amino acids per second.

MOLECULAR MARKERS.

21. . Write a note on RFLP analysis

The first methods for finding out genetics used for DNA profiling involved **RFLP analysis**. DNA is collected from cells, such as a blood sample, and cut into small pieces using a restriction enzyme (a restriction digest). This generates thousands of DNA fragments of differing sizes as a consequence of variations between DNA sequences of different individuals. The fragments are then separated on the basis of size using gel electrophoresis.

The separated fragments are then transferred to a nitrocellulose or nylon filter; this procedure is called a Southern blot. The DNA fragments within the blot are permanently fixed to the filter, and the DNA strands are denatured. Radiolabeled probe molecules are then added that are complementary to sequences in the genome that contain repeat sequences. These repeat sequences tend to vary in length among different individuals and are called variable number tandem repeat sequences or VNTRs. The probe molecules hybridize to DNA fragments containing the repeat sequences and excess probe molecules are washed away. The blot is then exposed to an X-ray film. Fragments of DNA that have bound the probe appear as dark bands on the film.

However, the Southern blot technique is laborious, and requires large amounts of undegraded sample DNA. Also, Karl Brown's original technique looked at many minisatellite loci at the same time, increasing the observed variability, but making it hard to discern individual alleles (and thereby precluding parental testing). These early techniques have been supplanted by PCR-based assays.

TECHNIQUES IN MOLECULAR BIOLOGY

22. Explain the basic principle of PCR.

Developed by Kary Mullis in 1983, a process was reported by which specific portions of the sample DNA can be amplified almost indefinitely (Saiki et al. 1985, 1988). This has revolutionized the whole field of DNA study. The process, the polymerase chain reaction (PCR), mimics the biological process of DNA replication, but confines it to specific DNA sequences of interest. With the invention of the PCR technique, DNA profiling took huge strides forward in

both discriminating power and the ability to recover information from very small (or degraded) starting samples.

PCR greatly amplifies the amounts of a specific region of DNA. In the PCR process, the DNA sample is denatured into the separate individual polynucleotide strands through heating. Two oligonucleotide DNA primers are used to hybridize to two corresponding nearby sites on opposite DNA strands in such a fashion that the normal enzymatic extension of the active terminal of each primer (that is, the 3' end) leads toward the other primer. PCR uses replication enzymes that are tolerant of high temperatures, such as the thermostable Taq polymerase. In this fashion, two new copies of the sequence of interest are generated. Repeated denaturation, hybridization, and extension in this fashion produce an exponentially growing number of copies of the DNA of interest. Instruments that perform thermal cycling are now readily available from commercial sources. This process can produce a million-fold or greater amplification of the desired region in 2 hours or less.

Early assays such as the HLA-DQ alpha reverse dot blot strips grew to be very popular due to their ease of use, and the speed with which a result could be obtained. However, they were not as discriminating as RFLP analysis. It was also difficult to determine a DNA profile for mixed samples, such as a vaginal swab from a sexual assault victim.

However, the PCR method was readily adaptable for analyzing VNTR, in particular STR loci. In recent years, research in human DNA quantitation has focused on new "real-time" quantitative PCR (qPCR) techniques. Quantitative PCR methods enable automated, precise, and high-throughput measurements. Interlaboratory studies have demonstrated the importance of human DNA quantitation on achieving reliable interpretation of STR typing and obtaining consistent results across laboratories.

WESTERN BLOTTING

23. . Describe the procedure of tissue preparation for western blotting

Tissue preparation

Samples can be taken from whole tissue or from cell culture. Solid tissues are first broken down mechanically using a blender (for larger sample volumes), using a homogenizer (smaller volumes), or by sonication. Cells may also be broken open by one of the above mechanical methods. However, virus or environmental samples can be the source of protein and thus western blotting is not restricted to cellular studies only.

Assorted detergents, salts, and buffers may be employed to encourage lysis of cells and to solubilize proteins. Protease and phosphatase inhibitors are often added to prevent the digestion of the sample by its own enzymes. Tissue preparation is often done at cold temperatures to avoid protein denaturing and degradation.

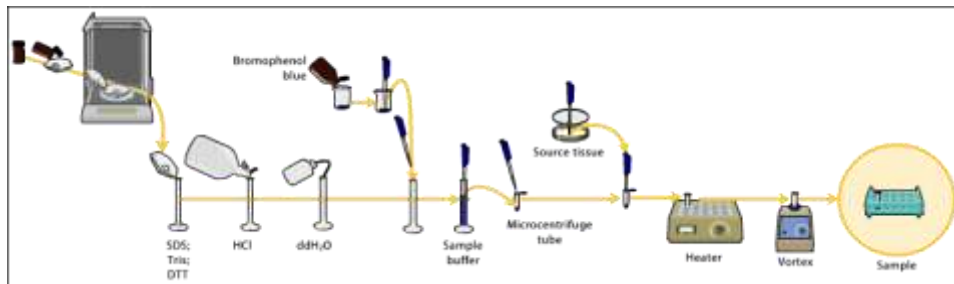

A combination of biochemical and mechanical techniques – comprising various types of filtration and centrifugation – can be used to separate different cell compartments and organelles.

GEL ELECTROPHORESIS FOR BLOTTING

24. . Explain the procedure of Gel electrophoresis for blotting

The proteins of the sample are separated using gel electrophoresis. Separation of proteins may be by isoelectric point (pI), molecular weight, electric charge, or a combination of these factors. The nature of the separation depends on the treatment of the sample and the nature of the gel. This is a very useful way to identify a protein.

By far the most common type of gel electrophoresis employs polyacrylamide gels and buffers loaded with sodium dodecyl sulfate (SDS). SDS-PAGE (SDS polyacrylamide gel electrophoresis) maintains polypeptides in a denatured state once they have been treated with strong reducing agents to remove secondary and tertiary structure (e.g. disulfide bonds [S-S] to sulfhydryl groups [SH and SH]) and thus allows separation of proteins by their molecular weight. Sampled proteins become covered in the negatively charged SDS and move to the positively charged electrode through the acrylamide mesh of the gel. Smaller proteins migrate faster through this mesh and the proteins are thus separated according to size (usually measured in kilodaltons, kDa). The concentration of acrylamide determines the resolution of the gel - the greater the acrylamide concentration, the better the resolution of lower molecular weight proteins. The lower the acrylamide concentration, the better the resolution of higher molecular weight proteins. Proteins travel only in one dimension along the gel for most blots.

Samples are loaded into *wells* in the gel. One lane is usually reserved for a *marker* or *ladder*, a commercially available mixture of proteins having defined molecular weights, typically stained

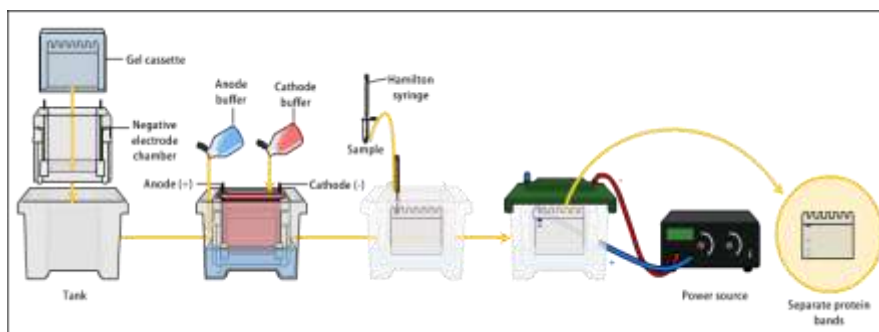

so as to form visible, coloured bands. When voltage is applied along the gel, proteins migrate through it at different speeds dependent on their size. These different rates of

advancement (different *electrophoretic mobilities*) separate into *bands* within each *lane*.

It is also possible to use a two-dimensional (2-D) gel which spreads the proteins from a single sample out in two dimensions. Proteins are separated according to isoelectric point (pH at which they have neutral net charge) in the first dimension, and according to their molecular weight in the second dimension.

25. Write the set up for blot transfer in western blotting

In order to make the proteins accessible to antibody detection, they are moved from within the gel onto a membrane made of *nitrocellulose* or *polyvinylidene difluoride*. The primary method for transferring the proteins is called electro blotting and uses an electric current to pull proteins from the gel into the PVDF or nitrocellulose membrane. The proteins move from within the gel onto the membrane while maintaining the organization they had within the gel. An older method of transfer involves placing a membrane on top of the gel, and a stack of filter papers on top of that. The entire stack is placed in a buffer solution which moves up the paper by capillary action, bringing the proteins with it. In practice this method is not used as it takes too much time; electroblotting is preferred. As a result of either "blotting" process, the proteins are exposed on a thin surface layer for detection. Both varieties of membrane are chosen for their non-specific protein binding properties (i.e. binds all proteins equally well). Protein binding is based upon hydrophobic interactions, as well as charged interactions between the membrane and protein. Nitrocellulose membranes are cheaper than PVDF, but are far more fragile and do not stand up well to repeated probings.

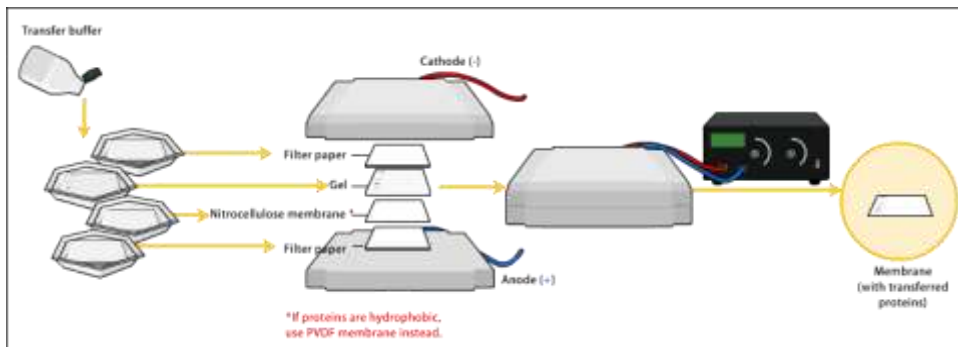

The uniformity and overall effectiveness of transfer of protein from the gel to the membrane can be checked by staining the membrane with Coomassie Brilliant Blue or Ponceau S dyes. Ponceau S is the more common of the two, due to its higher sensitivity and water solubility, the latter making it easier to subsequently destain and probe the membrane.

26. Describe the detection of bands on nitrocellulose paper

Since the membrane has been chosen for its ability to bind protein and as both antibodies and the target are proteins, steps must be taken to prevent the interactions between the membrane and the antibody used for detection of the target protein. Blocking of non-specific binding is achieved by placing the membrane in a dilute solution of protein - typically 3-5% Bovine serum albumin (BSA) or non-fat dry milk (both are inexpensive) in Tris-Buffered Saline (TBS) or I-Block, with a minute percentage (0.1%) of detergent such as Tween 20 or Triton X-100. The protein in the dilute solution attaches to the membrane in all places where the target proteins have not attached. Thus, when the antibody is added, there is no room on the membrane for it to attach other than on the binding sites of the specific target protein. This reduces "noise" in the final product of the western blot, leading to clearer results, and eliminates false positives.

Detection

During the detection process the membrane is "probed" for the protein of interest with a modified antibody which is linked to a reporter enzyme; when exposed to an appropriate substrate, this enzyme drives a colourimetric reaction and produces a color. For a variety of reasons, this traditionally takes place in a two-step process, although there are now one-step detection methods available for certain applications.

Two steps

- Primary antibody

The primary antibodies are generated when a host species or immune cell culture is exposed to protein of interest (or a part thereof). Normally, this is part of the immune response, whereas here they are harvested and used as sensitive and specific detection tools that bind the protein directly.

After blocking, a dilute solution of primary antibody (generally between 0.5 and 5 micrograms/mL) is incubated with the membrane under gentle agitation. Typically, the solution is composed of buffered saline solution with a small percentage of detergent, and sometimes with powdered milk or BSA. The antibody solution and the membrane can be sealed and incubated together for anywhere from 30 minutes to overnight. It can also be incubated at different temperatures, with higher temperatures being associated with more binding, both specific (to the target protein, the "signal") and non-specific ("noise").

- Secondary antibody

After rinsing the membrane to remove unbound primary antibody, the membrane is exposed to another antibody, directed at a species-specific portion of the primary antibody. Antibodies come from animal sources (or animal sourced hybridoma cultures); an anti-mouse secondary will bind to almost any mouse-sourced primary antibody, which allows some cost savings by allowing an entire lab to share a single source of mass-produced antibody, and provides far more consistent results. This is known as a secondary antibody, and due to its targeting properties, tends to be referred to as "anti-mouse," "anti-goat," etc. The secondary antibody is usually linked to biotin or to a reporter enzyme such as alkaline phosphatase or horseradish peroxidase. This means that several secondary antibodies will bind to one primary antibody and enhance the signal.

Most commonly, a horseradish peroxidase-linked secondary is used to cleave a chemiluminescent agent, and the reaction product produces luminescence in proportion to the amount of protein. A sensitive sheet of photographic film is placed against the membrane, and exposure to the light from the reaction creates an image of the antibodies bound to the blot. A cheaper but less sensitive approach utilizes a 4-chloronaphthol stain with 1% hydrogen peroxide; reaction of peroxide radicals with 4-chloronaphthol produces a dark purple stain that can be photographed without using specialized photographic film.

DNA FOOT PRINTING

27. What is DNA foot printing? Explain the procedure for same

DNA footprinting is a method of investigating the sequence specificity of DNA-binding proteins in vitro. This technique can be used to study protein-DNA interactions both outside and within cells.

The regulation of transcription has been studied extensively, and yet there is still much that is not known. Transcription factors and associated proteins that bind promoters, enhancers, or silencers to drive or repress transcription are fundamental to understanding the unique regulation of individual genes within the genome. Techniques like DNA footprinting will help elucidate which proteins bind to these regions of DNA and unravel the complexities of transcriptional control.

The simplest application of this technique is to assess whether a given protein binds to a region of interest within a DNA molecule. Polymerase chain reaction (PCR) amplify and label region of interest that contains a potential protein-binding site, ideally amplicon is between 50 to 200 base pairs in length. Add protein of interest to a portion of the labeled template DNA; a portion should remain separate without protein, for later comparison. Add a cleavage agent to both portions of DNA template. The cleavage agent is a chemical or enzyme that will cut at random locations in a sequence independent manner. The reaction should occur just long enough to cut each DNA molecule in only one location. A protein that specifically binds a region within the DNA template will protect the DNA it is bound to from the cleavage agent. Run both samples side by side on a polyacrylamide gel electrophoresis. The portion of DNA template without protein will be cut at random locations, and thus when it is run on a gel, will produce a ladder-like distribution. The DNA template with the protein will result in ladder distribution with a break in it, the "footprint", where the DNA has been protected from the cleavage agent.

DNA FINGERPRINTING: TECHNIQUE AND SIGNIFICANCE

28. Describe the technique of DNA finger printing

This is also known as 'DNA PROFILING' or 'DNA TYPING'. DNA fingerprinting is a technique to identify a person on the basis of his/her DNA specificity.

The practice of using thumbs impression of a person, as an identifying mark is very well known since long.

The study of finger, palm and sole prints is called dermatoglyphics and it has been a subject of human interest.

But, the concept of DNA fingerprinting is totally a new approach in the field of molecular biology. Sir Alec Jeffreys (1985-86) invented the DNA fingerprinting technique at Leicester University, United Kingdom.

Meaning:

DNA of an individual carries some specific sequence of bases, which do not carry any information for protein synthesis. Such nucleotide base sequences are repeated many times and are found in many places throughout the length of DNA. The number of repeats is very specific in each individual. The tandem repeats of short sequences are called 'mini satellites' or 'variable number tandem repeats' (VNTRs). Such repeats are used as genetic markers in personal identity.

Technique:

1. The first step is to obtain DNA sample of the individual in question.
2. DNA is also isolated from bloodstains, semen stains or hair root from the body of the victim or from victim's cloth even after many hours of any criminal offence. Even it can be obtained from vaginal swabs of rape victims. The amount of DNA needed for developing fingerprints is very small, only a few nanograms.
3. the DNA is digested with a suitable restriction endonuclease enzyme, which cuts them into fragments.
4. The fragments are subjected to gel electrophoresis by which the fragments are separated according to their size.
5. The separated fragments are copied onto a nitrocellulose filter membrane by Southern blotting technique.
6. Special DNA probes are prepared in the laboratory and made radioactive by labeling with radioactive isotopes. These probes contain repeated sequences of bases complimentary to those on mini satellites.
7. The DNA on the nitrocellulose filter membrane is hybridized with the radioactive probes and the free probes are washed off.
8. The bands to which the radioactive probes have been hybridized are detected through autoradiography. This is a technique where an X-ray film is exposed to the nitrocellulose membrane to mark the places where the radioactive DNA probes have bound to the DNA fragments. These places are marked as dark bands when X-ray film is exposed.
9. The dark bands on the X-ray film represent the DNA fingerprints or DNA profiles.

10. Comparison is made between the banding pattern of collected DNA sample and suspected human subject to confirm the criminal with hundred percent accuracy (Fig. below)

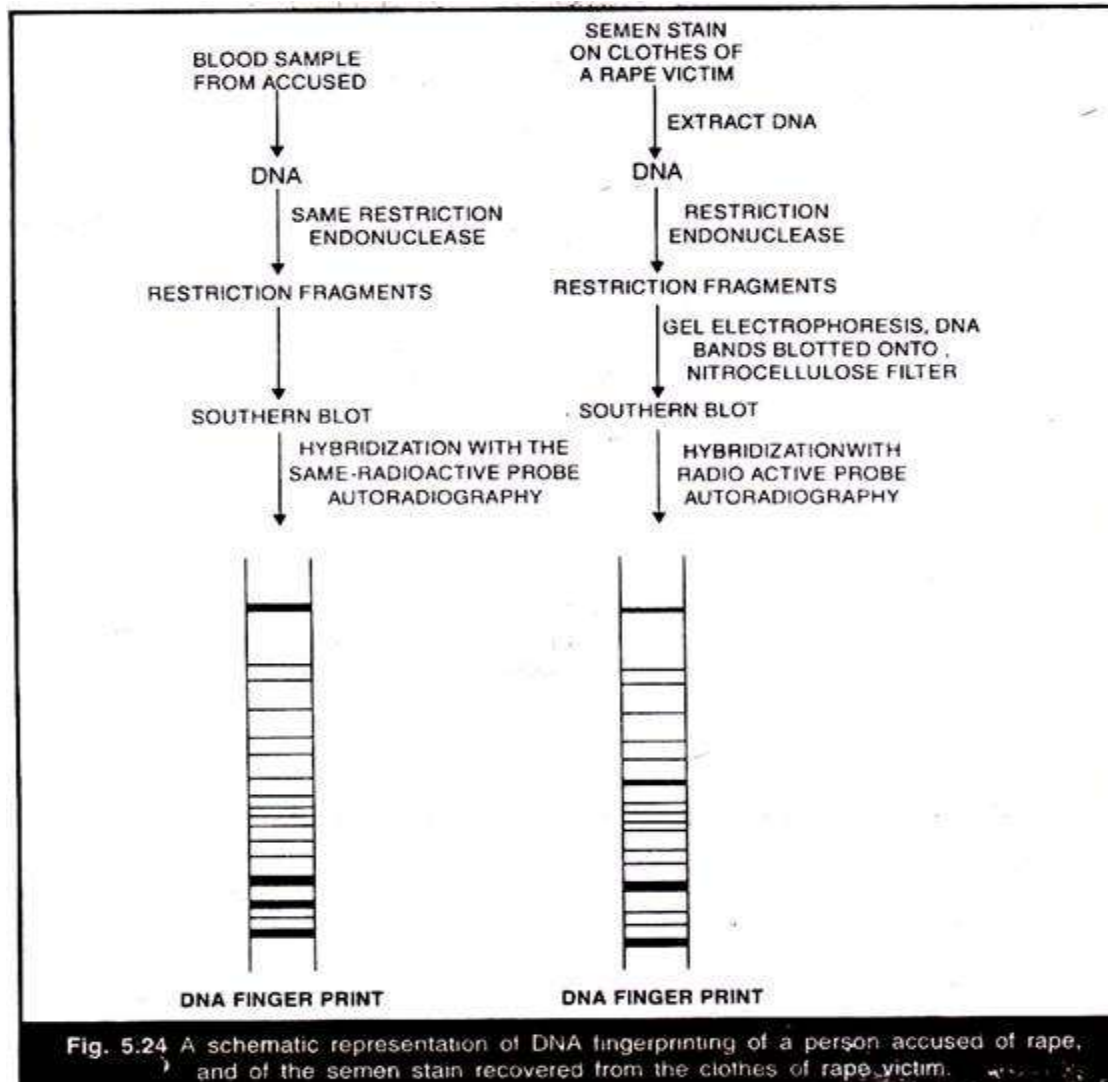

Significance:

1. The technique is extensively used as confirmatory test in crime detection in cases of rape and murder.

DNA SEQUENCING

29. Explaing Maxam-Gilbert Method of DNA sequencing

Allan Maxam and Walter Gilbert published a DNA sequencing method in 1977 based on chemical modification of DNA and subsequent cleavage at specific bases. Also known as chemical sequencing, this method allowed purified samples of double-stranded DNA to be used

without further cloning. This method's use of radioactive labeling and its technical complexity discouraged extensive use after refinements in the Sanger methods had been made.

Maxam-Gilbert sequencing requires radioactive labeling at one 5' end of the DNA and purification of the DNA fragment to be sequenced. Chemical treatment then generates breaks at a small proportion of one or two of the four nucleotide bases in each of four reactions (G, A+G, C, C+T). The concentration of the modifying chemicals is controlled to introduce on average one modification per DNA molecule. Thus a series of labeled fragments is generated, from the radiolabeled end to the first "cut" site in each molecule. The fragments in the four reactions are electrophoresed side by side in denaturing acrylamide gels for size separation. To visualize the fragments, the gel is exposed to X-ray film for autoradiography, yielding a series of dark bands each corresponding to a radiolabeled DNA fragment, from which the sequence may be inferred.

26. Describe Chain-termination method or sangers method of DNA sequencing

The chain-termination method developed by Frederick Sanger and coworkers in 1977 soon became the method of choice, owing to its relative ease and reliability. When invented, the chain-terminator method used fewer toxic chemicals and lower amounts of radioactivity than the Maxam and Gilbert method. Because of its comparative ease, the Sanger method was soon automated and was the method used in the first generation of DNA sequencers.

Sanger sequencing is the method which prevailed from the 80's until the mid-2000s. Over that period, great advances were made in the technique, such as fluorescent labelling, capillary electrophoresis, and general automation. These developments allowed much more efficient sequencing, leading to lower costs.

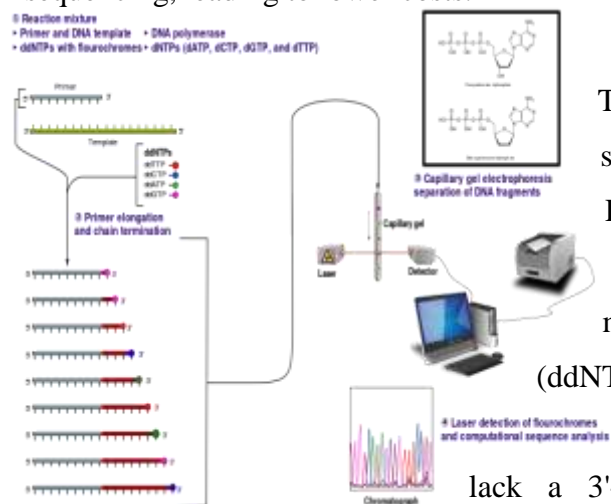

The classical chain-termination method requires a single-stranded DNA template, a DNA primer, a DNA polymerase, normal deoxynucleosidetriphosphates (dNTPs), and modified di-deoxynucleotidetriphosphates (ddNTPs), the latter of which terminate DNA strand elongation. These chain-terminating nucleotides lack a 3'-OH group required for the formation of a phosphodiester bond between two nucleotides, causing DNA polymerase to cease extension of

DNA when a modified ddNTP is incorporated. The ddNTPs may be radioactively or fluorescently labeled for detection in automated sequencing machines.

The DNA sample is divided into four separate sequencing reactions, containing all four of the standard deoxynucleotides (dATP, dGTP, dCTP and dTTP) and the DNA polymerase. To each reaction is added only one of the four dideoxynucleotides (ddATP, ddGTP, ddCTP, or ddTTP), while three other nucleotides are ordinary ones. Putting it in a more sensible order, four separate reactions are needed in this process to test all four ddNTPs. Following rounds of template DNA extension from the bound primer, the resulting DNA fragments are heat denatured and separated by size using gel electrophoresis. In the original publication of 1977,^[2] the formation of base-paired loops of ssDNA was a cause of serious difficulty in resolving bands at some locations. This is frequently performed using a denaturing polyacrylamide-urea gel with each of the four reactions run in one of four individual lanes (lanes A, T, G, C). The DNA bands may then be visualized by autoradiography or UV light and the DNA sequence can be directly read off the X-ray film or gel image.

In the image on the right, X-ray film was exposed to the gel, and the dark bands correspond to DNA fragments of different lengths. A dark band in a lane indicates a DNA fragment that is the result of chain termination after incorporation of a dideoxynucleotide (ddATP, ddGTP, ddCTP, or ddTTP). The relative positions of the different bands among the four lanes, from bottom to top, are then used to read the DNA sequence.

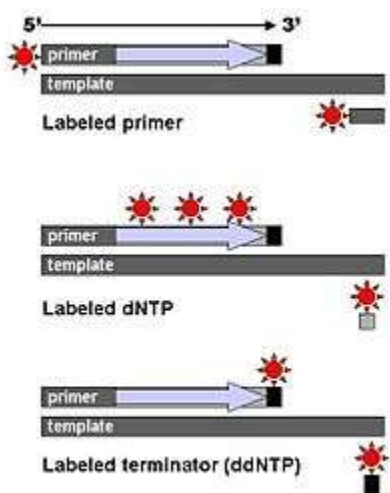

DNA fragments are labelled with a radioactive or fluorescent tag on the primer (1), in the new DNA strand with a labeled dNTP, or with a labeled ddNTP. (click to expand)

Technical variations of chain-termination sequencing include tagging with nucleotides containing radioactive phosphorus for radiolabelling, or using a primer labeled at the 5' end with a fluorescent dye. Dye-primer sequencing facilitates reading in an optical system for faster and more economical analysis and automation. The later development by Leroy Hood and coworkers^{[3][4]} of fluorescently labeled

ddNTPs and primers set the stage for automated, high-throughput DNA sequencing.

Sequence ladder by radioactive sequencing compared to fluorescent peaks

Chain-termination methods have greatly simplified DNA sequencing. For example, chain-termination-based kits are commercially available that contain the reagents needed for sequencing, pre-aliquoted and ready to use. Limitations include non-specific binding of the primer to the DNA, affecting accurate read-out of the DNA sequence, and DNA secondary structures affecting the fidelity of the sequence.
